

labmodul

SYSTEM STANDARD



# SYSTEM STANDARD

- Flexible and movable
- Future-orientated and suited for all purposes
- High quality for daily use
- Great load bearing
- Smart design
- High vertical
- Easy to Clean



## SYSTEM STANDARD

STANDARD is a movable furniture system with strong constructions designed for easy combination. The system is compatible to our other system solutions which.

All constructions are thoroughly tested and the furniture system is produced of resistant and robust materials to ensure a durable solution for many years of daily use.

Furthermore, the materials are carefully chosen with focus on recycling and sustainability.

The STANDARD furniture system is exceedingly flexible because of the aluminium framework that makes it possible to shorten the modules to the desired width.

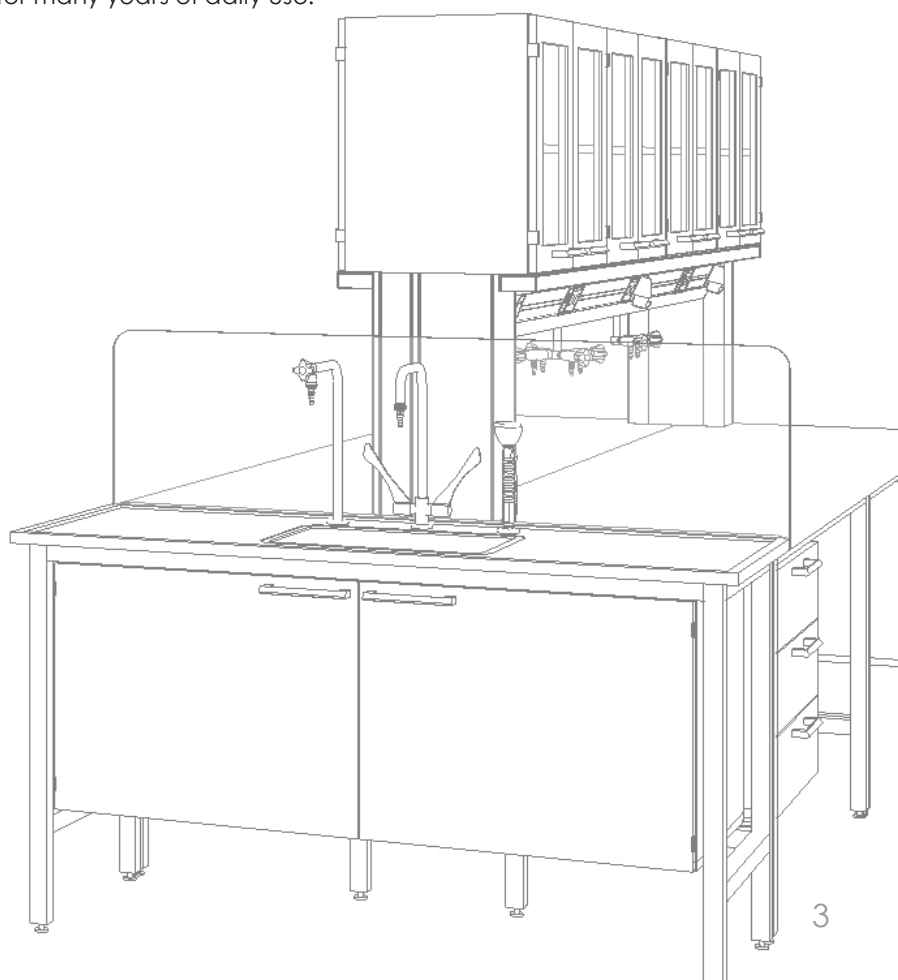
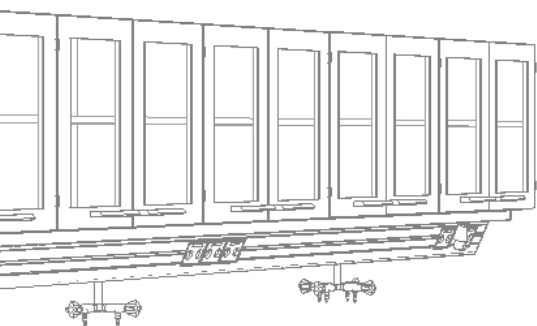

## A broad program

Standard is delivered with a broad range of different worktop and front materials to choose from along with different types of hinges and drawer handles to fit the desired cabinet function precisely.

Drawers are delivered with 80 % soft close pull out as standard or with 110 % soft close + pull out.

The base cabinets are mounted hanging in runners and can easily be moved by pulling the cabinet sideways

The flexibility of the system allows seating, workstations and sub worktable equipment to be established where needed.

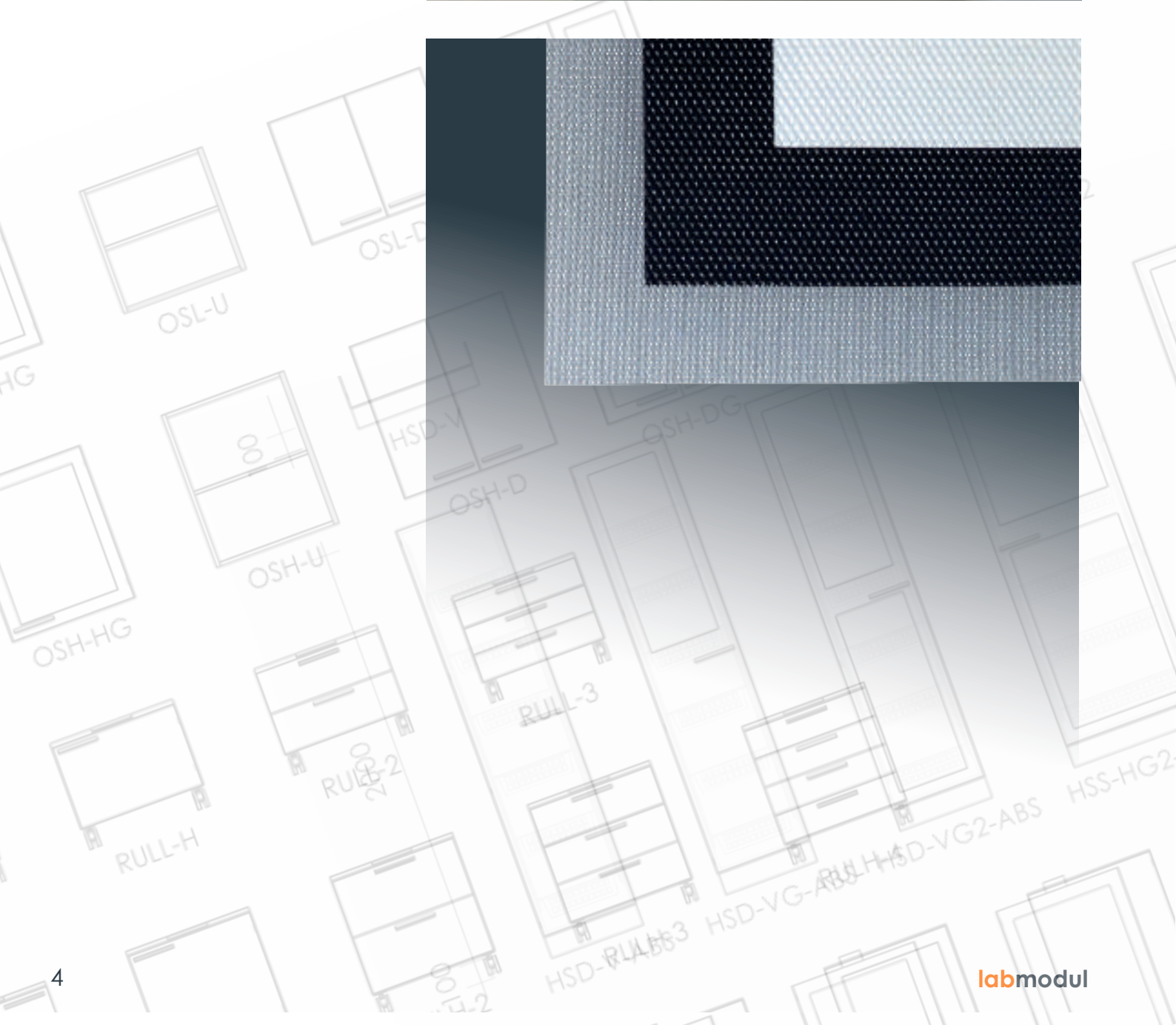
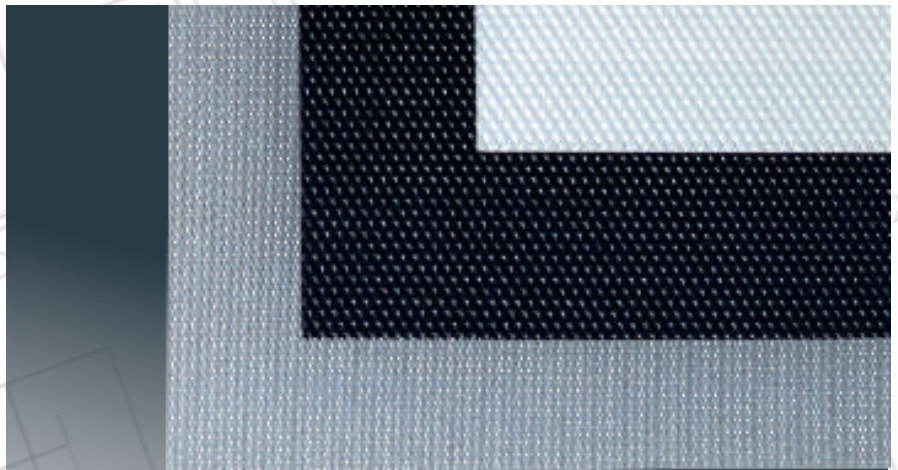





## Good ergonomics

The tables can be delivered with different types of electrical height-adjustability.

We offer 2 different control panels for the height-adjustability systems:

- up / down buttons
- up/down buttons with memory function for 3 personal settings



- Activator for normal loads (200 kg.)



- Hydraulic for heavy loads (300 kg.)



- Mobilekit loads (150 kg.)





## Service Bridges

The service bridges/panels have built-in working light that illuminates the worktops with a convincing 900 lux. The distribution of the light above the worktops creates a clear and comfortably lit working area.

The lighting fittings have tight-fitting transparent lids for easy and efficient cleaning. The service bridges/panels are offered in two versions- a low model with horizontal plugs and a high model with vertical plugs.

The low model maximises between opposite working areas. The high model gives easy access to the plugs and is advantageous where equipment is often plugged in or out.

## Installations

Both models are prepared for additional mounting of extra outlets.

The service bridges/panels are delivered with all technical installations and outlets for power and plumbing ready for use.

The installations end in a chosen pick-up point for quick and easy connection to the building's installations.

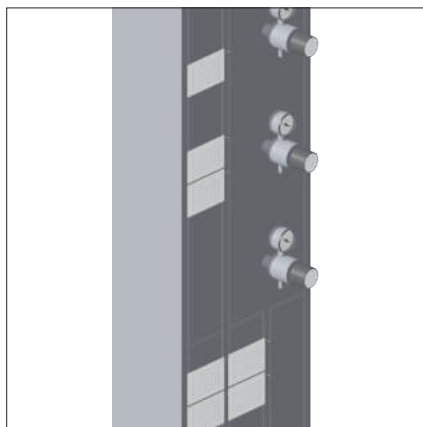

*By utilizing the combinations units between 1 and 2 module cover plates, in conjunction with the movable cover can technique tower simply and flexibly meet a variety of functional requirements and configurations.*

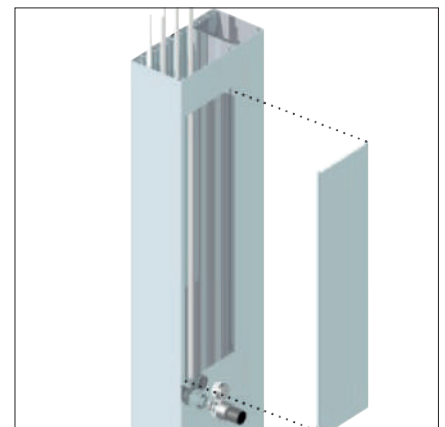

*Cover sheets removability gives easy access during installation and servicing. Future modifications / changes are made easy.*





## Fronts

- Heighpressure laminate
- Compact laminate
- Linolium
- Corian



## Glass cabinet fronts

- Natural anodised 20 mm aluminum frame with 110° hinges
- White powder coated 20 mm aluminum frame with 110° hinges
- Laminate 60 mm frame with 270° hinges
- Laminate 60 mm frame concealed 110° hinges

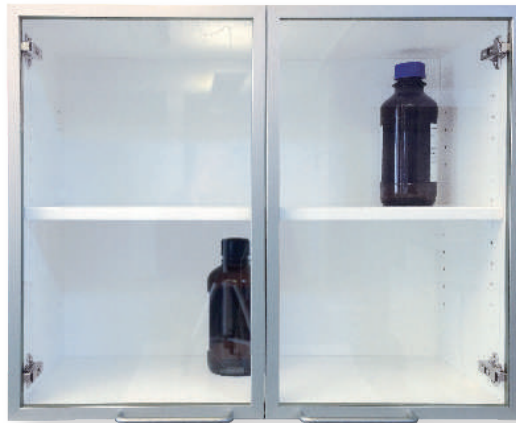

## Handles

- Standard logistics aluminum handles with inclined surface for example Dymo strips. Width 190 mm
- Handle in brushed stainless steel. Width 160 mm
- Handle in matt aluminium. Width 160 mm



# Countertops

### Material options

- Laminate
- Compact laminate
- Stainless steel
- Corian
- Glass

### Laminate colors

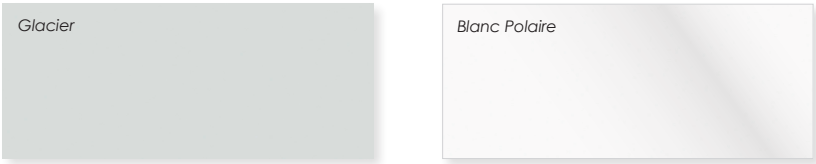

# Fronts

### Materials

- Laminate
- Compact laminate
- Corian

### Laminate colors

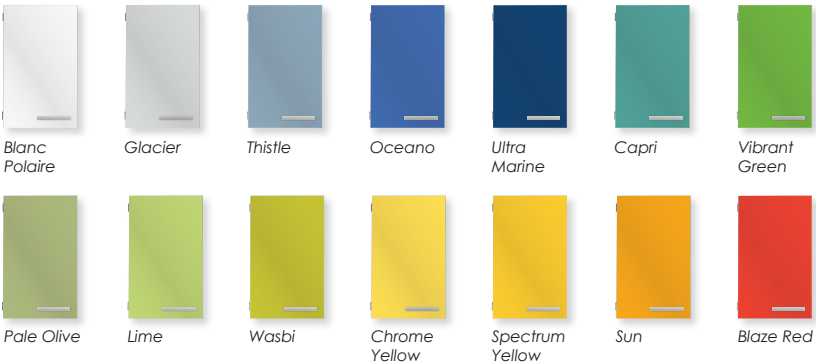

# Plinths

Two standard colors

### Laminate colors



# Tabletop profiles

### Front edge

### Rear edge

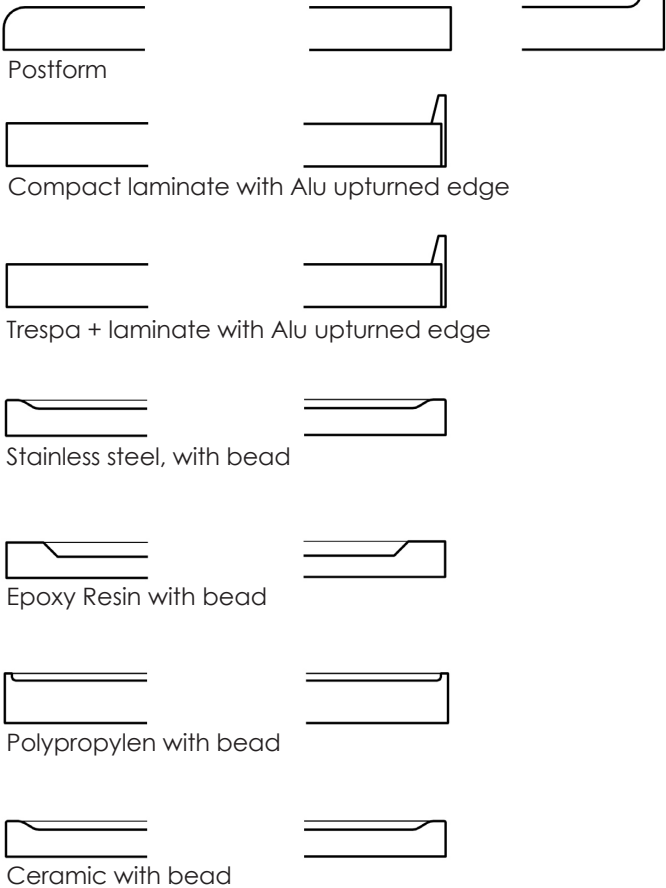



## Accessories for Service Bridges

The unique bridge is prepared for various mounting solutions that intelligently indemnify the desktop for other tasks. The suspensions can be moved throughout the length of the bridge so that the desired function is at your fingertips



**TOWEL HOLDER**  
Aluminium finish, width 570 mm



**MOUNTINGS STAND**  
Aluminium finish, width 380 mm



**PAPERTOWELHOLDER**  
Aluminium finish, W352 x D150 x H255 mm



**PAPERTOWELHOLDER - 3 levels**  
Aluminium finish, W352 x D150 x H305 mm



**KNIFE HOLDER**  
Aluminium finish, W380 x D80 x H370 mm



**UNIVERSAL SHELF**  
Aluminium finish, W440 x D150 x H275 mm



**DOUBLE SHELF**  
Aluminium finish, W380xD80xH275 mm



**DOCUMENT HOLDER**  
Aluminium finish, W440 x D74 x H320 mm



**DEVIDER HOLDER**  
Aluminium finish, W380 x D190 x H255 mm



**WASH RACK**  
Aluminium finish, W380 x D80 x H370 mm



**CUP HOLDER**  
Aluminium finish, W147 x D150 x H335 mm, Incl. cup Ø147 mm

## Sink worktops

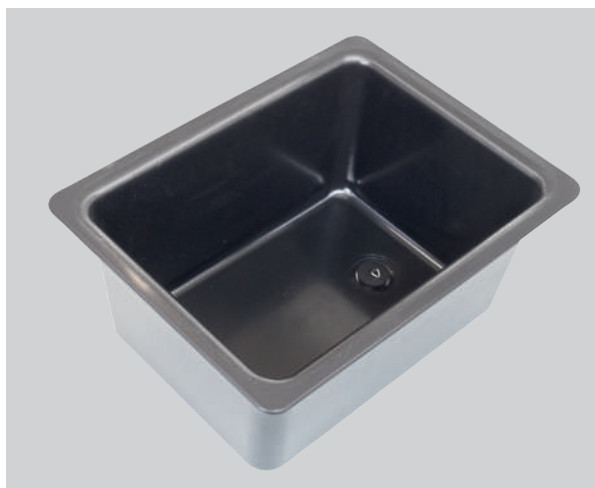
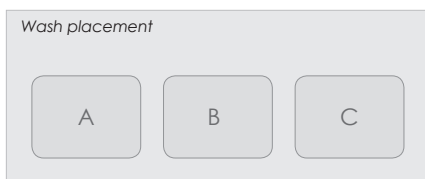

### Polypropylene sinks

- PPDK1 265x117x185 mm, Drip cup
- PPDK2 Ø170x115 mm, Drip cup
- PP320 320x320x200 mm
- PP400 400x400x250 mm
- PP500 500x400x250 mm
- PP600 600x400x250 mm

## Worktop materials

- High-pressure laminate
- Compact laminate
- Polypropylene (PP)
- Epoxy Resin
- Acid resistant stainless steel ASI316
- Ceramics



### Ceramic sinks

- KKDK1 Ø105x112 mm, Drip cup
- KKDK2 250x95x112 mm, Drip cup
- KK400 400x400x250 mm
- KK500 500x400x250 mm
- KK600 600x400x250 mm

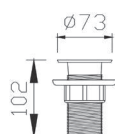

Drain plug 97B0070P



### Epoxy Resin sinks

- S497 150x70x108 mm, Drip cup
- S499 229x76x134 mm, Drip cup
- S1000 250x125x150 mm, Drip cup
- SDS5-DI 300x200x200 mm
- SA5-DI 356x254x152 mm
- SN9-DI 406x305x203 mm
- SGL 10-DI 400x400x300 mm
- SM8-DI 450x365x200 mm
- SEL 16-DI 600x450x300 mm
- SVL15-DI 635x381x254 mm



Overflow pipe 158mm 97B0158



### Stainless steel sinks

- TR100 Ø100 mm round Funnel
- TR150 Ø150 mm round Funnel
- DK130 Ø130mm round Drip cup
- DK250 250x150x100 mm, Drip cup
- A340 340x300x200 mm
- A400 400x340x145 mm
- A480 480x340x180 mm
- A500 500x400x160 mm
- A600 600x400x200 mm

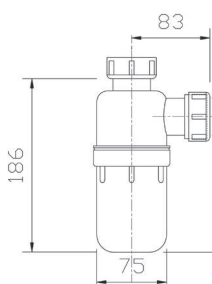

Water trap 97B0080

# Product Information

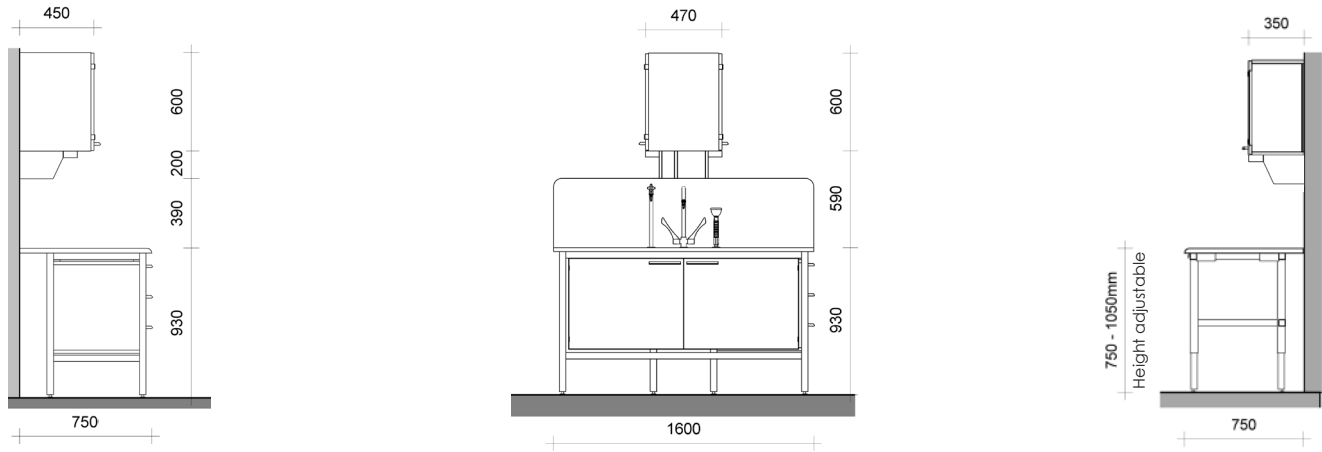

## Cabinets

### Top cabinet - Wall hanging

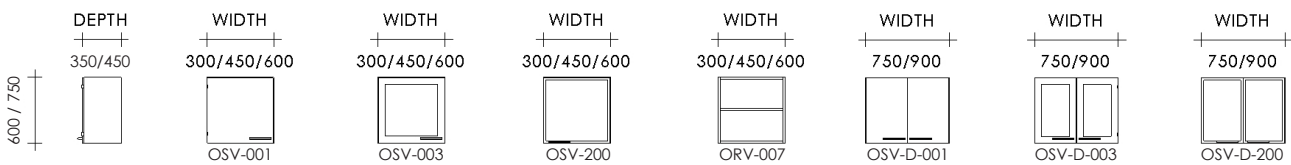

### Top cabinet - Free standing

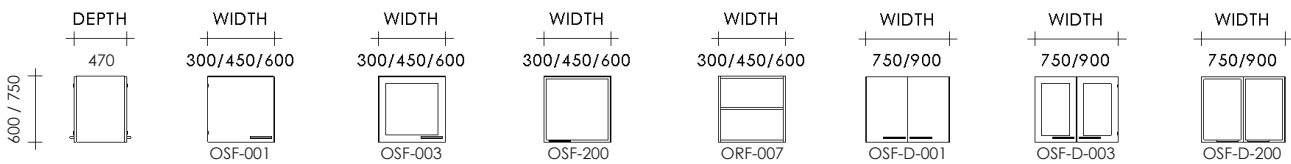

### Suspended under bench sink cabinet

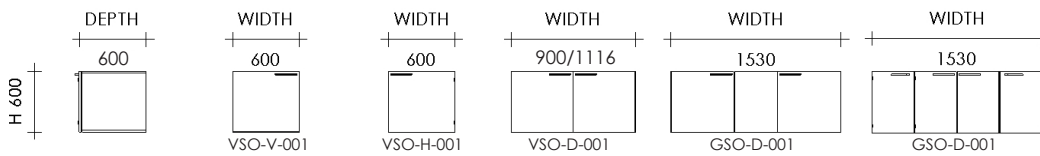

### Mobile units - low

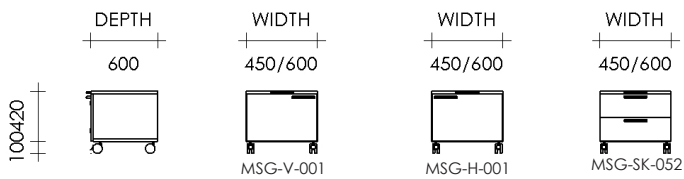

### Mobile units - high

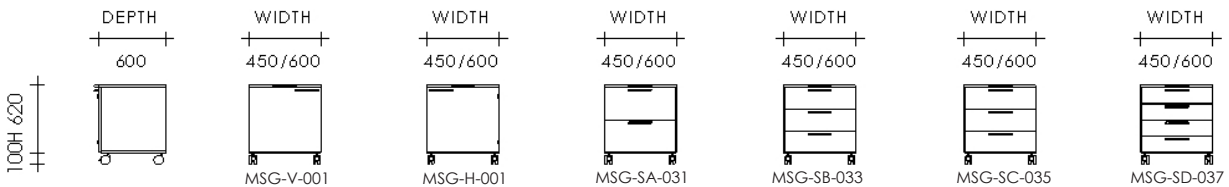

### Suspended under bench cabinet - low

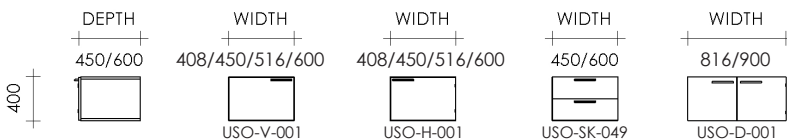

### Suspended under bench cabinet - high

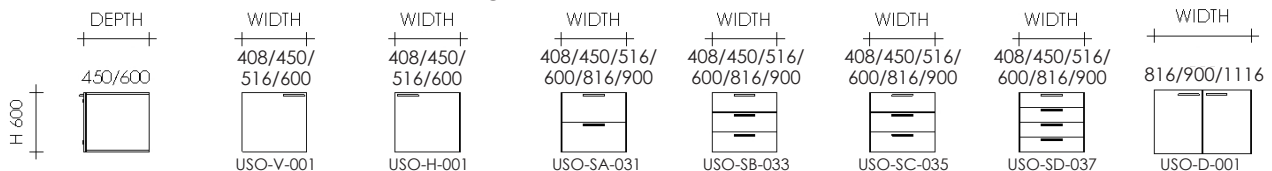



# Tall storage cabinets

## Storage cabinets HSS

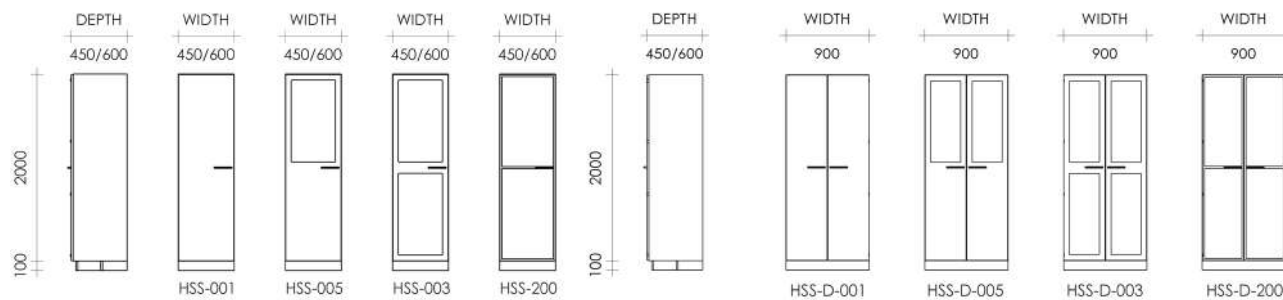

## Adjustable shelves

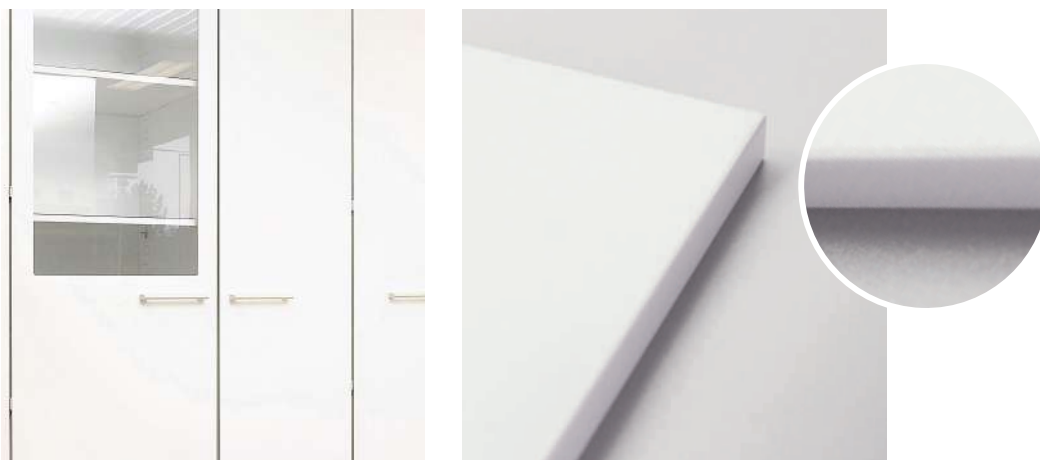

## Storage cabinets system 60/40 for trays and baskets

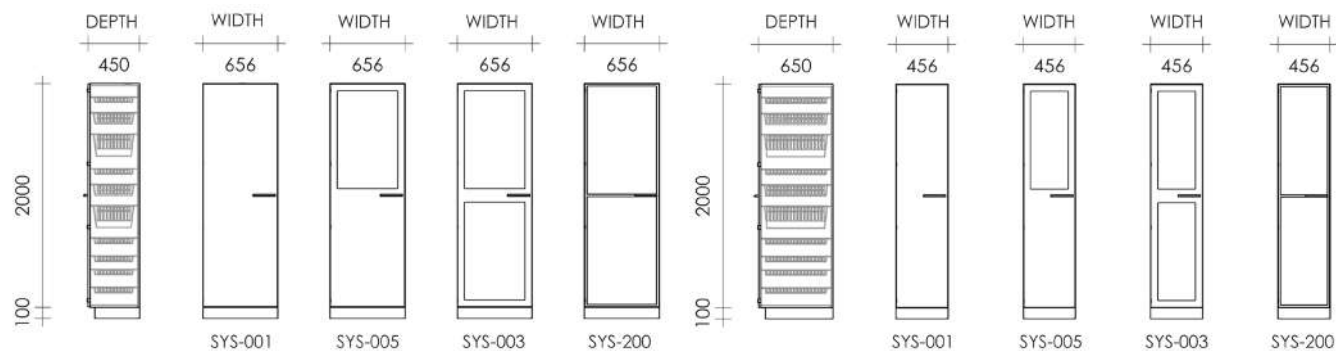

## Trays and baskets



See the selection of trays and baskets in a separate brochure



Storage cabinets KSS for chemicals and poison with moveable shelves protected by glass / depth 450 mm and 600 mm

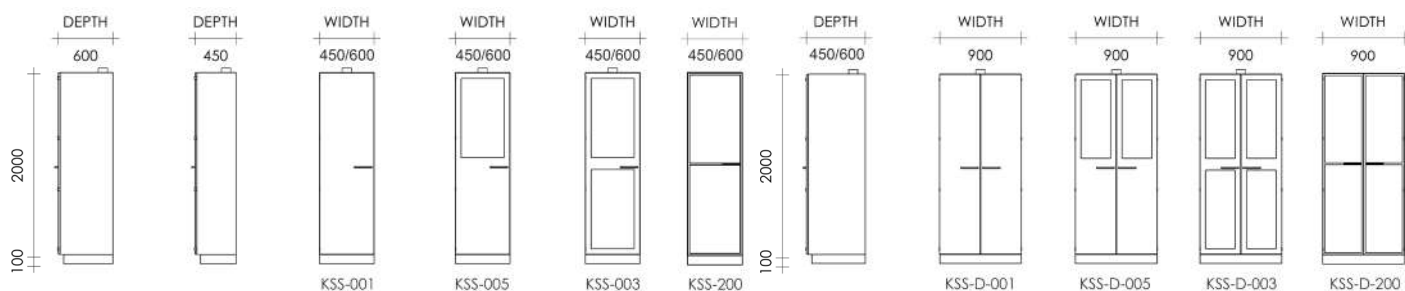

Adjustable shelves with protective glass



Storage cabinets KSS for chemicals and poison with pull-out / depth 600 mm

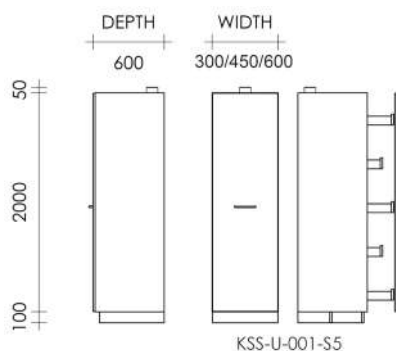
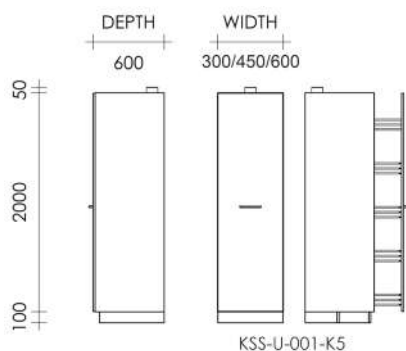

Pull-out door and 5 pc. of moveable wire baskets



Pull-out door and drawers with soft-close



Fire cabinet / depth 617 mm

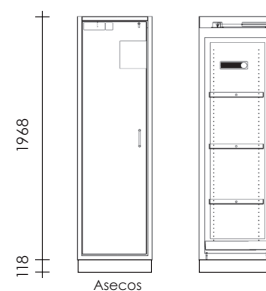

Fire Resistant acid / chemicals cupboard with self closing door



# Product Information

Wall mounted

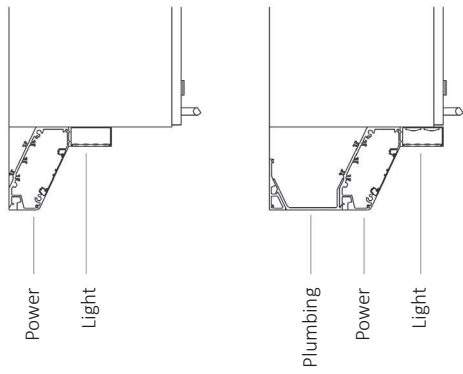

# Service Bridges

Freestanding sections

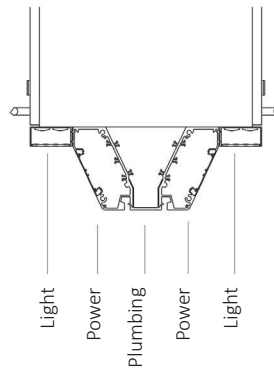

# Installations

- Water
- Gas
- Power

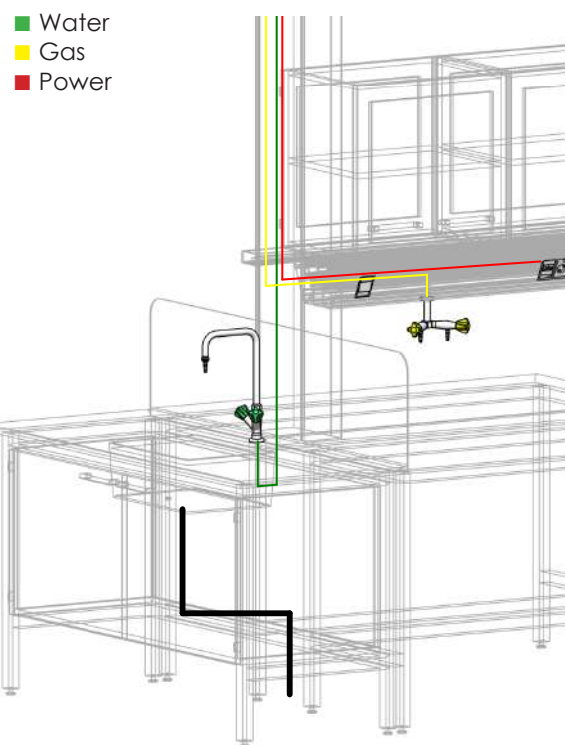
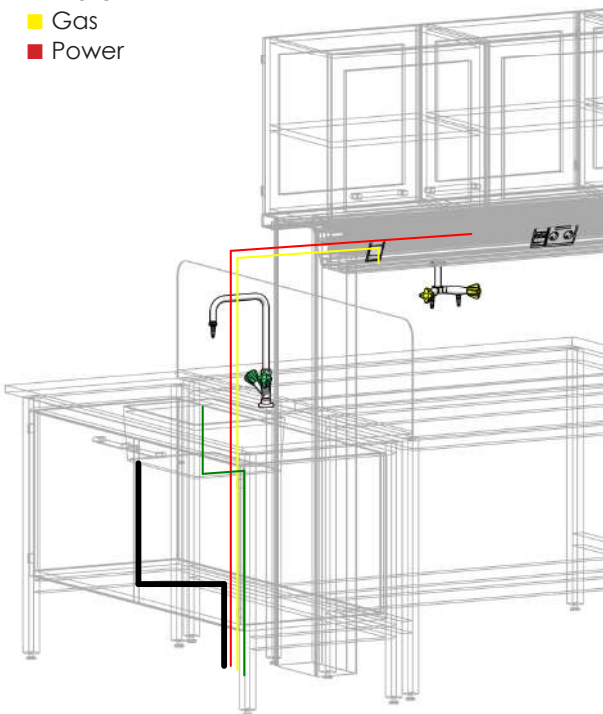

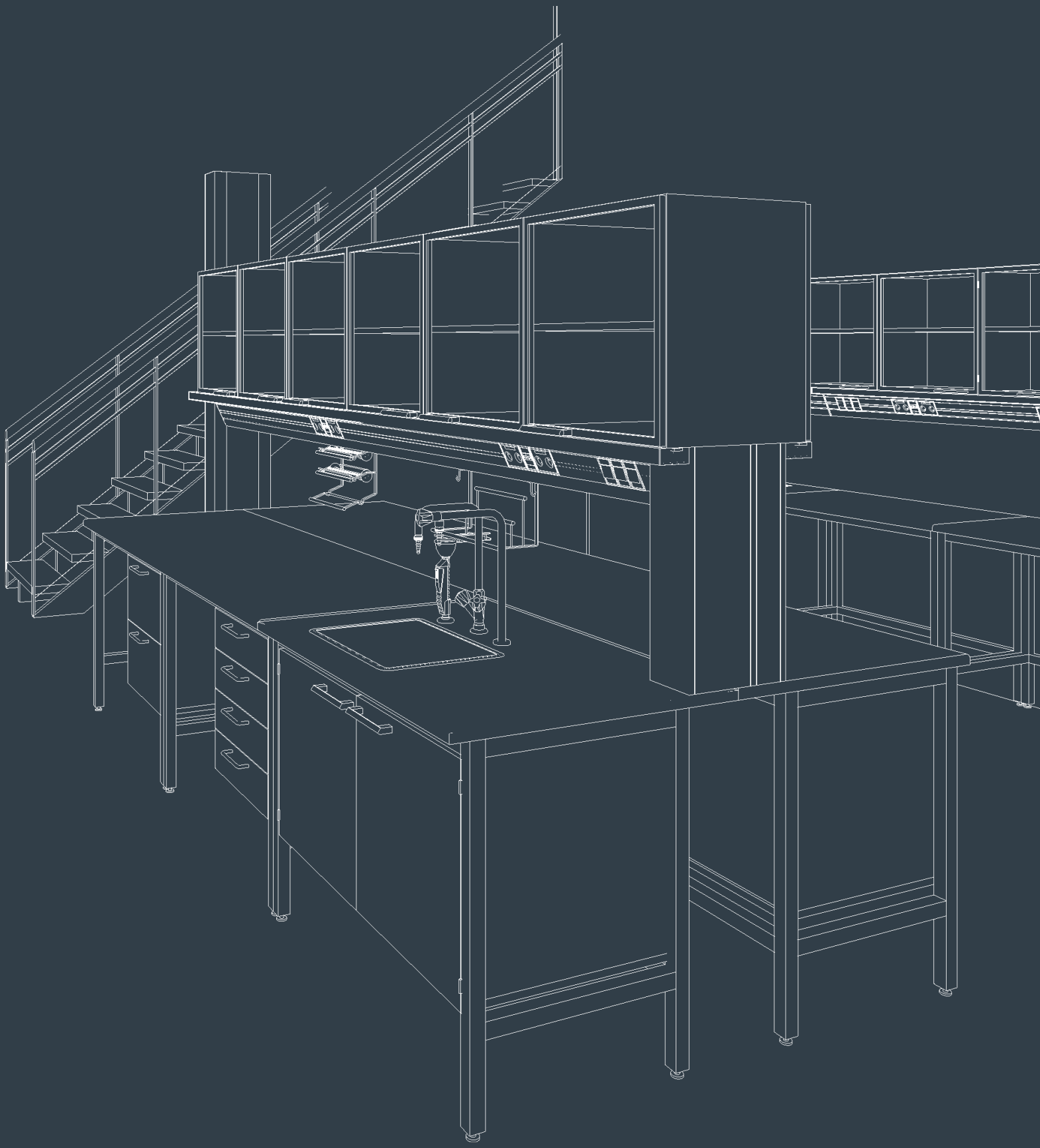

**labmodul**

Valhøjs Alle 190, DK-2610 Rødovre, Tlf. +45 70 21 21 89